

PCB dimension

Mounting dimension

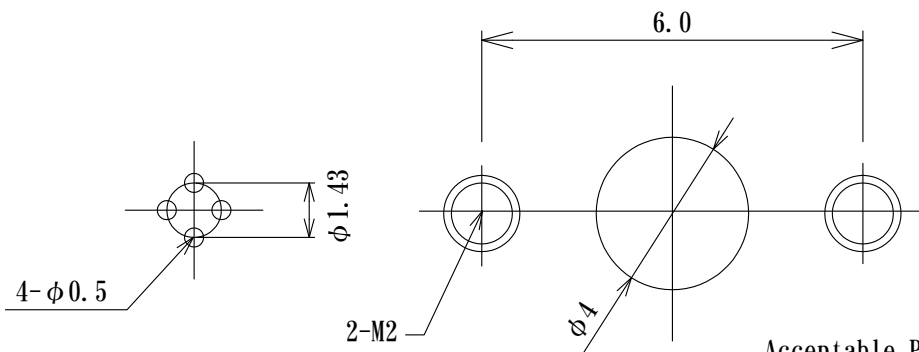

Acceptable Plug  $\phi 0.35$  typical

Date	JC ELECTRONICS CORPORATION	
2014/12/26		
Materials Finish	SOCKET PINS	Contact: Beryllium Copper Gold over Ni Plated
	INSULATOR	Body: Brass Gold over Ni Plated LCP (Black)
Dimensions Style mm	Title	LASER DIODE SOCKET
Third Angle Projection	Part Number	LD143-4P-M2L180-E
Rev. No	0	